



TEKNİK-İŞ

MUSTAFA USTA



www.t-is.com.tr



www.t-is.com.tr

[Değerlerimiz]

[güven]



[güç]



[teknoloji]



[şeffaflık]



[zaman]



[tasarım]



[kalite]



[farklılık]



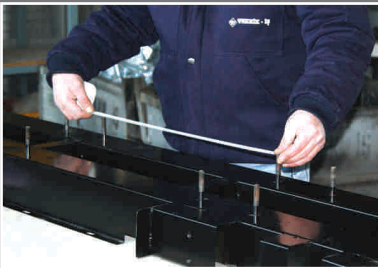

KALİTE POLİTİKAMIZ;

Otomotiv, Tağ ve Sinyal Direkleri, Gemi, Beyaz Eşya sektörüne yan sanayii olarak hizmet veren firmamızda; Müşteri beklenti ve isteklerini, müşterimizle belirleyerek deneyimli teknik kadroların yönetiminde üretim yapmak temel ilkemizdir.

İlkelerimizi gerçekleştirme;

Tüm personele Toplam Kalite Felsefesini benimsetmek, bilgi ve becerilerinin artırılmasına yönelik iç ve dış eğitimlerin sürekliliğini sağlamak, Ürün maliyetini düşürmek için, en çağdaş teknolojiyi kullanmak ve sıfır hata ile üretim hedefine ulaşmak, Sürekli iyileştirme Felsefesini uygulayarak, Müşteri ve Çalışan memnuniyetini artırmak, Doğaya saygı prensibimizi, çevreye hizmetlerimizle kanıtlamak Müşteriler ile sürekli bilgi alış verişinde bulunarak sisteme entegre olmalarını sağlamak Müşteri memnuniyetinin ana koşulunun, kaliteli girdi temeliyle mümkün olacağı anlayışından hareketle; tedarikçilerimizin kalite seviyelerini yükseltmelerine destek olmak Ana hedefimizdir.

Bugünkü Teknik-İş'in ilk temelleri 1983 yılında İstanbul Soğanlıkta kalıp üretim atölyesi olarak atıldı.

Teknik-İş kısa süre içerisinde 3.500m² kapalı alan üzerine kurulu modern tesisinde makina parkı ve uzman kadrosuyla ciddi ve önemli atılımlar yaparak sektöründeki gelişmelere ayak uydurmuştur.

Teknik-İş sektöründeki deneyimi, profesyonel kadrosu ve sürekli yenilenen teknolojisi ile sektörde seçkin bir konuma gelmekle birlikte, tam fonksiyonlu hizmet sunma konusunda haklı ve iddialı duruma gelmiştir.

Otomotiv, Tağ ve Sinyal Direkleri, Gemi, Beyaz Eşya sektöründeki çalışmalarımız, mutlak müşteri memnuniyeti ve artan bir ivmeyle devam edecektir.



*Tasarım,
Teknik çizim,
ve uygulama*



*Ölçüm ve
Kalite kontrol*



CERTIFICATE NO. 29728



LCS – DMS TAG



Çelik hammedde, Galvaniz kaplama,



İstenilen ölçü ve ebat, Farklı aparat ilave parça,
Özel tasarım ve uygulama.





LCS – DMS TAG

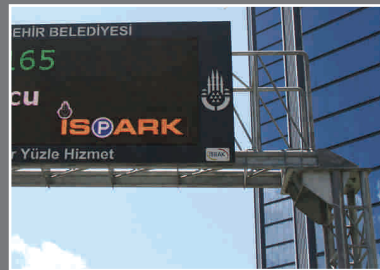



LCS – DMS TAG





TEKNİK-İŞ

MUSTAFA USTA



LCS – DMS TAG Konsul Tipi

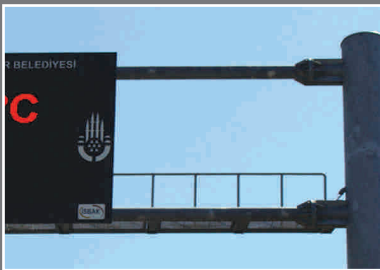



E.D.S. Direği



TAG Sistemli Sinyalizasyon Direği



Çelik hammedde, Galvaniz kaplama,



İstenilen ölçü ve ebat, Farklı aparat ilave parça,
Özel tasarım ve uygulama.

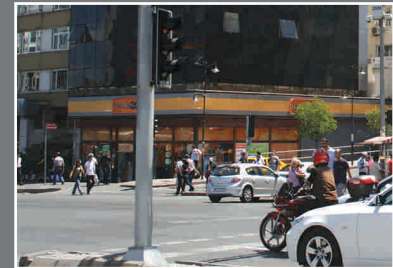

Aydınlatmalı, Yön Levhali Başüstü Sinyal Direği



Çelik hammedde, Galvaniz kaplama,



Standart Ölçü, Tabela, Aydınlatma Işığı bağlama Aparatı.



Standart Sinyal Direği



Çelik hammede, Galvaniz kaplama





Çelik hammedde, Galvaniz kaplama

Başüstü Sinyal Direği Direği



Teleskopik Levha Diređi



*Galvaniz kaplama,
İsteđe bađlı toz boya,
Boy uzatıp, kısaltma aparatı.*



Koruma kapađı,

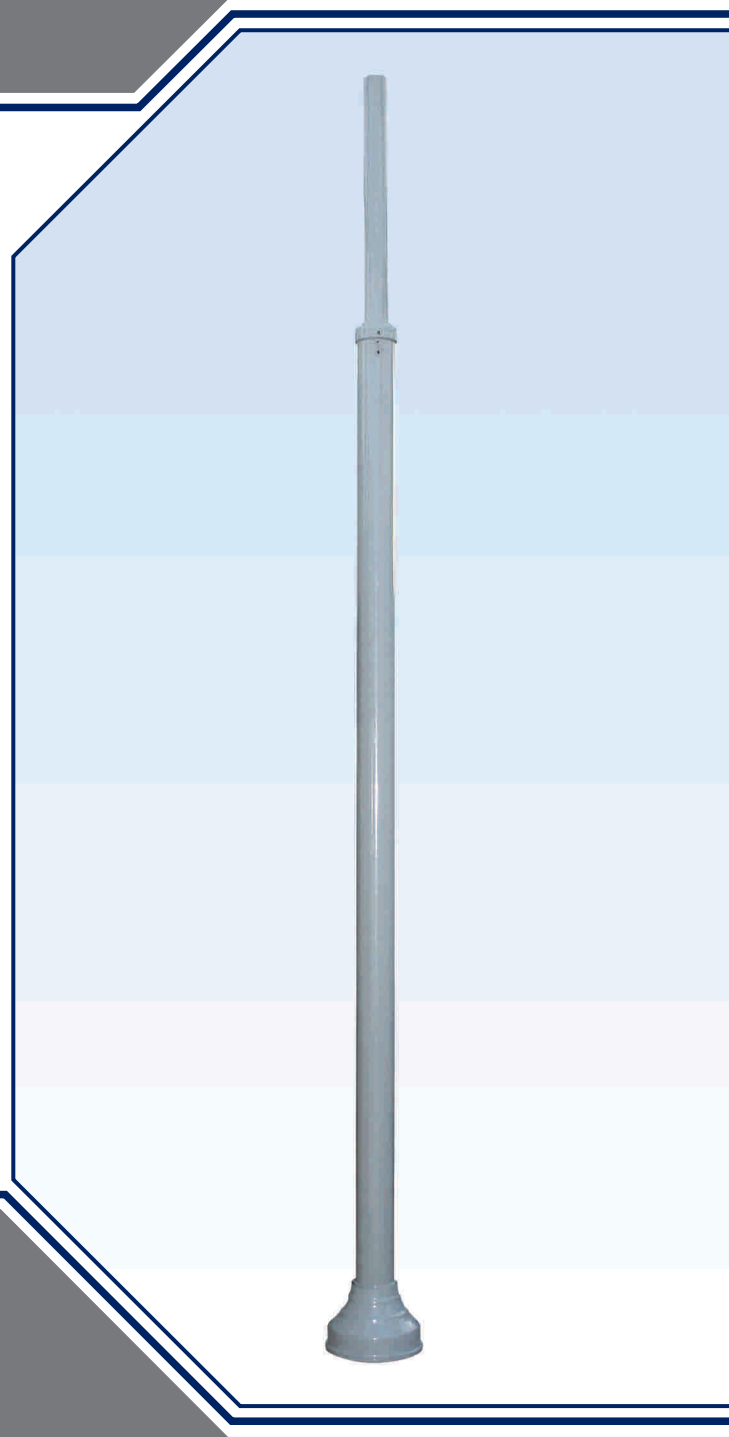

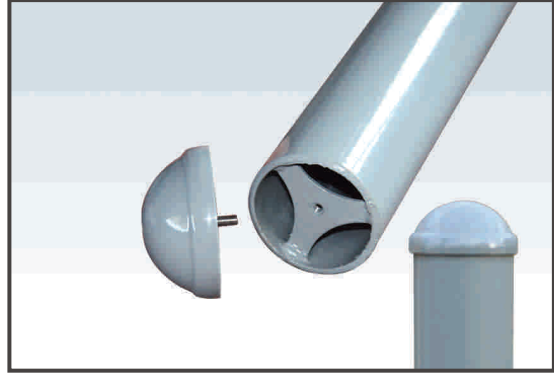

Ölçü, boy: 2,00m
Ölçü, boy: 2,50m
Ölçü, boy: 3,00m
Ölçü, boy: 3,50m

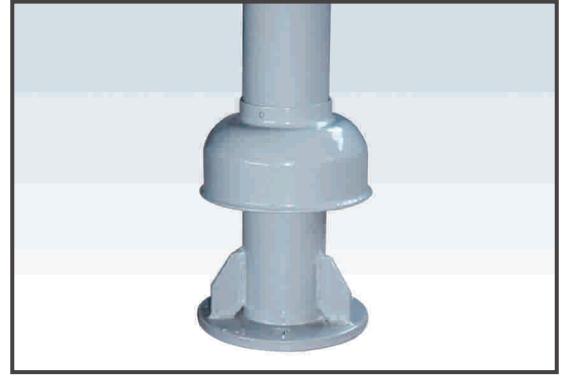

Galvaniz kaplama,
İsteğe bağlı toz boya.

Levha Direkleri





Otomotiv Yan Sanayi Parçaları

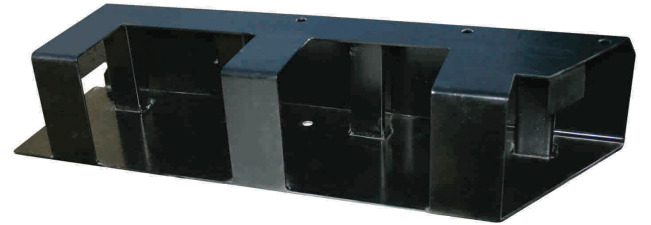
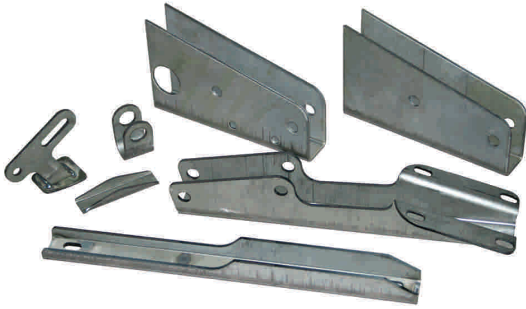
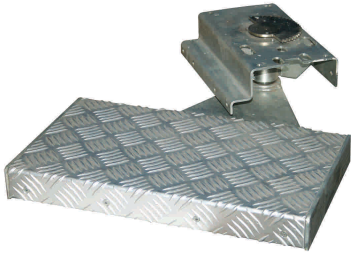

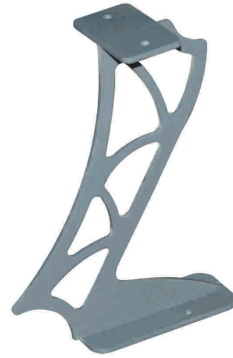
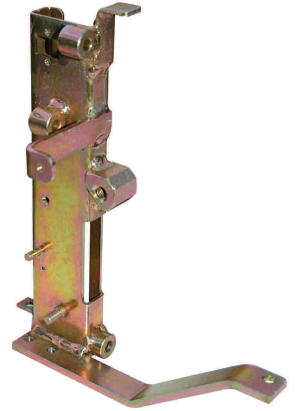

Üretim Departmanı

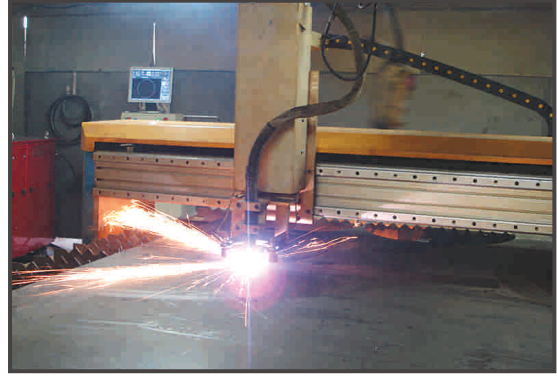

PRESHANE KAYNAKHANE



KALIPHANE BOYAHANE



ÖZEL ÜRÜN

TALEPLERİNİZDE

EN İYİ EN YENİ ÇÖZÜMLER
TEKNİK-İŞ FARKIYLA

Müşterilerimizin talebinde
bulduğu ürünlerin
teknik çizim, resim
veya numunelerine
göre en hızlı
şekilde üretim.



TEKNİK-İŞ

[Referanslarımız]



Nakış Edasıyla İşliyoruz...



ASKAM KAMYON

FAHRİ
Otomotiv Makina
Sanayi Ticaret

FARHYM
Otom. San. Tic. Ltd. Şti.

SEDEF
Gemi İnşa A.Ş.



TEKNİK-İŞ



Necip Fazıl Mh. Düzce Sk. No.49
Sultanbeyli - İSTANBUL

Tel.: +90.216 497 31 06

+90.216 497 32 13

+90.216 497 32 54

Fax: +90.216 497 31 57

www.t-is.com.tr

e-mail: teknikis@t-is.com.tr